

# DRAWING FOR CUSTOMER

- SPEC.:
- Rated Voltage:125V AC,DC
  - Rated Current:1A AC,DC
  - Withstand Voltage:500V AC/minute
  - Contact Resistance:30mΩ max
  - Insulation Resistance:100MΩ min
  - Temperature Range:-25℃~+85℃
  - Applicable wire:AWG#28~32

- Material:
- Insulator:PA66 UL94V-0
  - Color:White

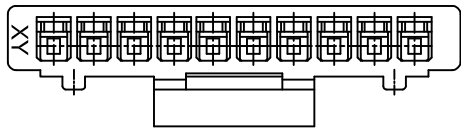
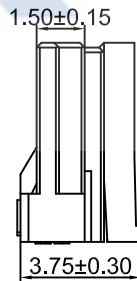
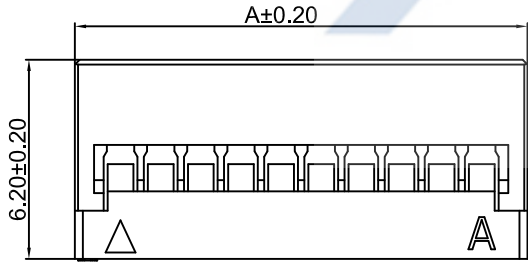
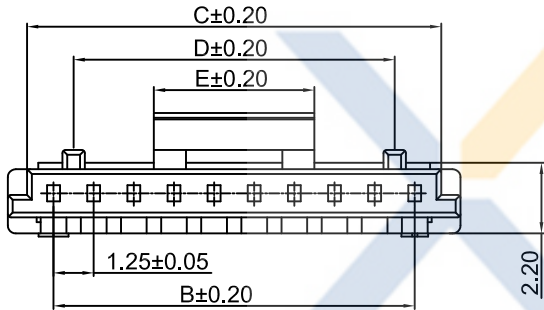
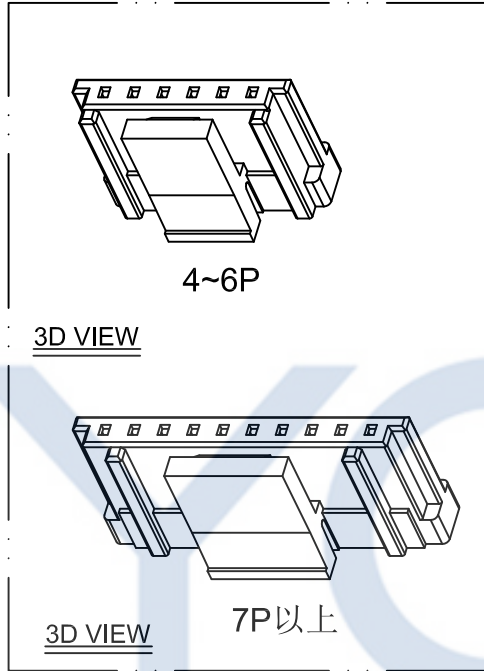
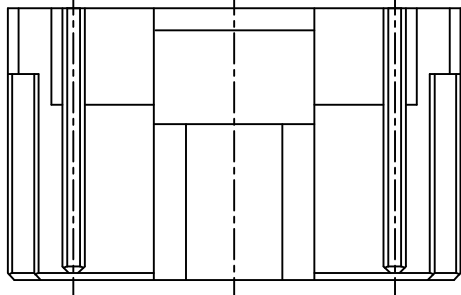
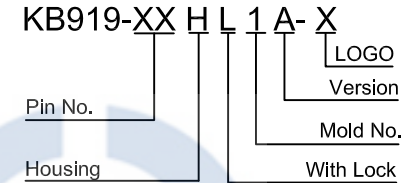

Poles	Dimensions (mm)				
	A	B	C	D	E
05	7.85	5.00	6.65	5.95	3.60
06	9.10	6.25	7.90	7.20	3.60
07	10.35	7.50	9.15	6.25	3.60
08	11.60	8.75	10.40	7.50	5.00
09	12.85	10.00	11.65	8.75	5.00
10	14.10	11.25	12.90	10.00	5.00
11	15.35	12.50	14.15	11.25	5.00
12	16.60	13.75	15.40	12.50	5.00
13	17.85	15.00	16.65	13.75	9.00
14	19.10	16.25	17.90	15.00	9.00
15	20.35	17.50	19.15	16.25	9.00
16	21.60	18.75	20.40	17.50	9.00
17	22.85	20.00	21.65	18.75	9.00
18	24.10	21.25	22.90	20.00	9.00
19	25.35	22.50	24.15	21.25	9.00
20	26.60	23.75	25.40	22.50	9.00

**XYCO** 东莞市轩业电子科技有限公司  
 TEL: 0769-8297 9981/2/3 <http://www.XYCO.com.cn>

2020-03-15	A	新模	KB919-XXHL1A-X	Devin	TOLERANCE 公差	DRAWING 設計者	Devin	KB919-XXHL1A-X	
DATE 日期	VER 版本	CHANGE HISTORY 變更歷史	CHANGED NAME 修改後料號	DRAWING 變更者	.X=±0.30 .XX=±0.20 .XXX=±0.10	CHECKED 審查	Thomas	PART NO. 料號	
						APPROVED 核准	William	DWG NO. 圖號	PE200302A

UNIT 單位	mm	PRODUCT NAME 產品名稱	12507 PH1.25mm Wire To Board Housing With Lock